

System Overview

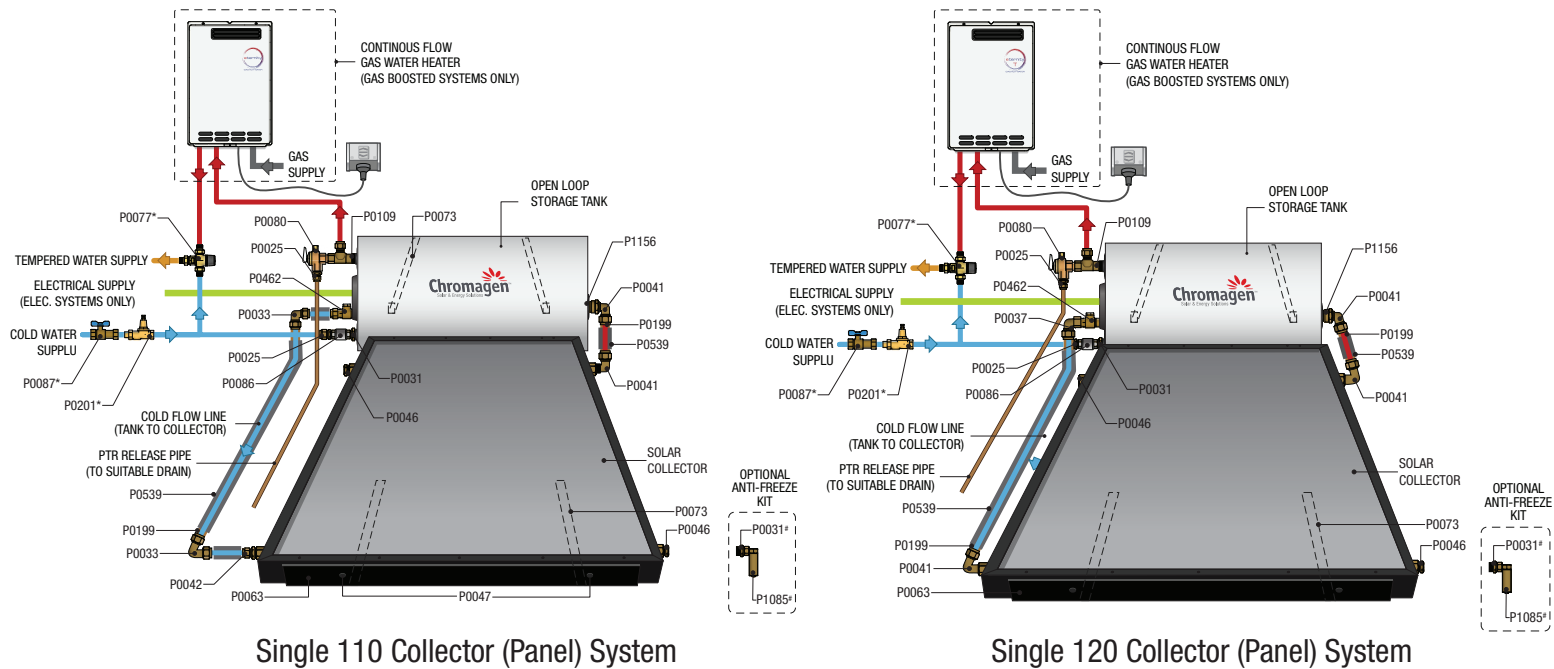

Single 110 Collector (Panel) System

Single 120 Collector (Panel) System

Part Kits & Components

NOTE: System schematic is indicative only

Parts not included in standard kits (* to be supplied by installer):

Part#	Qty Req'd	Component Name
P0087	1	Duo valve
P0201	1	Pressure limiting valve
P0077	1	Tempering valve

Standard components / kits included with the thermosiphon systems:

200L Gas - Open Loop System (Single 110 Panel)	200L Gas - Open Loop System (Single 120 Panel)	300L Gas - Open Loop System (Single 120 Panel)	200L Electric - Open Loop System (Single 110 Panel)	200L Electric - Open Loop System (Single 120 Panel)	300L Electric - Open Loop System (Single 120 Panel)
1 x 200L OL Tank	1 x 200L OL Tank	1 x 300L OL Tank	1 x 200L OL Tank	1 x 200L OL Tank	1 x 300L OL Tank
1 x Collector Panel	1 x Collector Panel	1 x Collector Panel	1 x Collector Panel	1 x Collector Panel	1 x Collector Panel
1 x Conn. Kit (K0005)	1 x Conn. Kit (K0006)	1 x Conn. Kit (K0010)	1 x Conn. Kit (K0005)	1 x Conn. Kit (K0006)	1 x Conn. Kit (K0010)
1 x Gas Booster	1 x Gas Booster	1 x Gas Booster	-	-	-

Connection Kit (K0005 / K0006 / K0010)

Part#	Qty			Component Name
	K0005	K0006	K0010	
P0025	2	2	2	Union 15mm MI - Conetite
P0031	1	1	1	Hex Nipple 20mm MI - 15mm MI
P0033	2	-	-	Elbow 20mm Conetite
P0037	-	1	1	Elbow 20mm FI - Conetite
P0040	-	1	1	Union 20mm MI - 15mm Conetite
P0041	2	3	3	Elbow 20mm MI - Conetite
P0042	2	-	-	Union 20mm MI - Conetite
P0046	2	2	2	Plug 20mm Brass
P0047	2	2	4	Self Tapping Screw

Connection kit (Continued)

P0063	1	1	1	Rail for Single Collector
P0073	4	4	4	Strap - Tank/Collector Rail
P0080	1	1	1	PTR Valve
P0086	1	1	1	Non-Return Valve
P0109	1	1	1	Tee 15 FI / 20 MI / 15 Conetite
P0199	1	1	1	Copper Length - Long
P0199	1	1	1	Copper Length - Short
P0462	1	1	1	Thermosiphon Arrestor Valve
P0539	4	4	4	Aero Flex Insulation
P1156	1	1	1	Adaptor - Hot Return Socket

INSTALLATION SHALL CONFORM TO THE PLUMBING CODE OF AUSTRALIA (PCA)

WARNING – THIS APPLIANCE MAY DELIVER WATER AT HIGH TEMPERATURE. REFER TO THE PLUMBING CODE OF AUSTRALIA (PCA), LOCAL REQUIREMENTS AND INSTALLATION INSTRUCTIONS TO DETERMINE IF ADDITIONAL DELIVERY TEMPERATURE CONTROL IS REQUIRED.

K0005
K0006
K0010

Collector Connection Points

IMPORTANT! Before lifting and fitting the collectors to the roof, ensure all brass fittings are connected to the collectors.

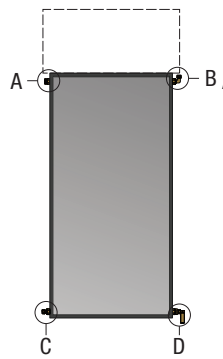

Single 110 Collector (Panel) System

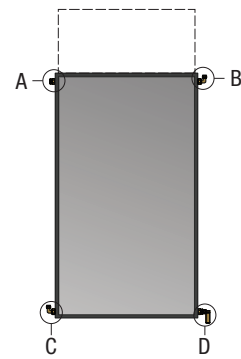

Single 120 Collector (Panel) System

Collector Connections Table

The table below indicates all brass fittings & connections to be fitted to collector/s before lifting to roof area

Connection Location	Fit	Image
A	Plug 20mm Brass	
B	Elbow 20mm MI - Conetite	
C ¹ (110 Collector Panels)	Union 20mm MI - Conetite	
C ² (120 Collector Panels)	Elbow 20mm MI - Conetite	
D ¹ (Without Antifreeze Protection)	Plug 20mm Brass	
D ² (With Antifreeze Protection)	Hex Nipple 20mm MI - 15mm MI Brass [#]	
	Frost (antifreeze) Valve 15mm Brass [#]	

[#] Components supplied in Antifreeze Kits

IMPORTANT! Ensure all connections are tight and leak-free

IMPORTANT! Frost valves are required for all solar hot water installations in Victoria. Frost valves must always be installed at an angle equal to the roof surface or facing down to allow water to drain freely. Installing the valve incorrectly may result in water freezing inside the valve and valve failure. Frost valve should be inspected annually and replaced as required.

Tank Connection Points

IMPORTANT! Before lifting and fitting the tank to the roof, ensure all brass fittings are connected to the tank.



NOTE: D varies depending on number of panels and tank size (refer to table below)

NOTE:

The cold water inlet line requires an approved isolating non-return valve. In some locations regulations require a pressure relief valve be fitted to the cold water supply. All hot water pipes must be insulated

Tank Connections Table

The table below indicates all brass fittings & connections to be fitted to tank before lifting to roof area

Connection Location	Fitting	Image
A: Cold Water Inlet	Reducing Nipple 20mm - 15mm	
	Non Return Valve	
	Union 15mm MI - Conetite	
B: Hot Water Outlet	Tee 15mm FI / 20mm MI / 15mm Conetite	
	PTR Valve	
	Union 15mm MI - Conetite	
C: Collector Cold Flow	Thermosiphon Arrestor Valve 20mm MI - Conetite <i>(Remove Conetite fitting for 120 panel systems)</i>	
D: Collector Hot Return (Single Panel)	Adaptor - Hot Return Socket 20mm MI - 20mm FI (with copper insertion)	
	Elbow 20mm FI - Conetite	

IMPORTANT! Ensure all connections are tight and leak-free

Installing Flat Plate Collector

Preparation

1. Check the roof for broken/loose tiles and rusted/loose tin sheets, and make good?
2. Before preparing to lift the collector onto the roof area, install all brass fittings to the collector using appropriate jointing methods and referring to the relevant collector connections table (page 2)

Fitting the collector mounting rails

3. Fit collector mounting rail to roof area using the appropriate method below:

To Tiled Roofs (Fig 1 & 2)

- a. Fold stainless steel bottom straps in half feed through the eyelets on the black collector rail with suitable spacing (Fig 1).
- b. Position the bottom collector rail on the front edge of a tile ensuring the rail is at least 500mm up from the gutter
- c. Angle the collector rail slightly (max 2° from horizontal) on the side where the hot outlet will be, to allow any air to be bled from the highest point (Fig 4).
- d. Remove the tiles above the rail at strap location and secure the straps to the batten with suitable fasteners
- e. Replace tiles and make good

To Tin / Metal Roofs (Fig 3)

- a. Remove screws along batten line where collector rail is to be fastened. Ensure rail position is at least 500mm up from the gutter
- b. Angle the collector rail slightly (max 2° from horizontal) on the side where the hot outlet will be, to allow any air to be bled from the highest point (Fig 4)
- c. Mark hole locations and pre-drill collector mounting rail
- d. Place rubber washers between collector mounting rail and roof surface at each hole
- e. Re-attach roofing screws through collector rail into existing screw holes of roof sheeting

NOTE: If a batten is not in a suitable position use the straps provided and feed through collector mounting rail (Fig 1) and fasten straps to a suitable roof batten through the roof sheeting.

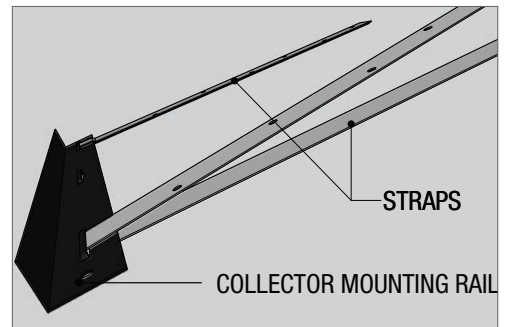

Fig 1

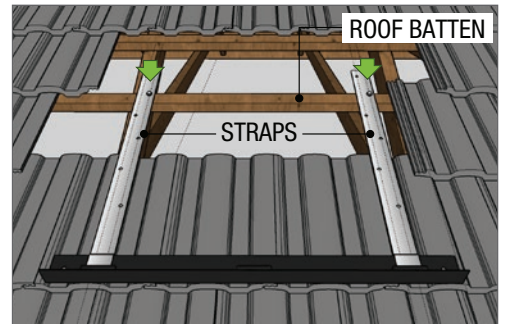

Fig 2

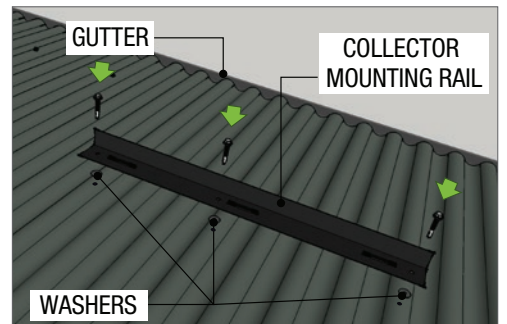

Fig 3

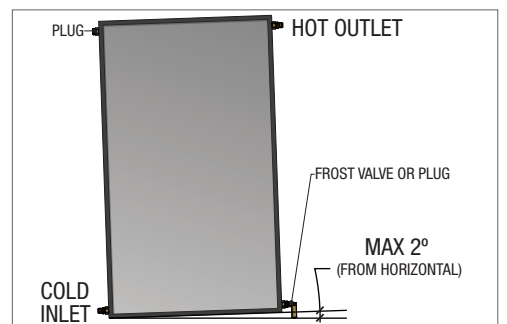

Fig 4

Attaching the collector

4. Fit a cover over the collector to ensure you don't get burnt by the hot surface
5. Safely lift the collector (with the pre-fitted brass fittings) to the roof area
6. Position the collector on the collector mounting rail (Fig 5)
7. Fasten the collector to the mounting rail using the screws supplied (Fig 6)
8. Secure the TOP strap/s to the top horizontal section of the collector with the screws supplied (Fig 7). NOTE. Do not use longer screws than those supplied or the copper header pipe in the collector may be pierced, causing leaks
9. Fix the top collector strap to roof either directly through tin / metal sheet and into batten below (Fig 8) or by removing tiles and fastening directly to batten (Fig 9). Replace tiles back over the fastened strap

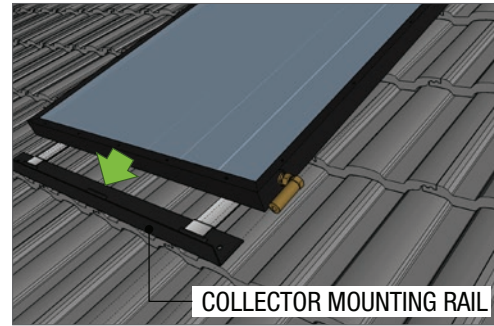

Fig 5

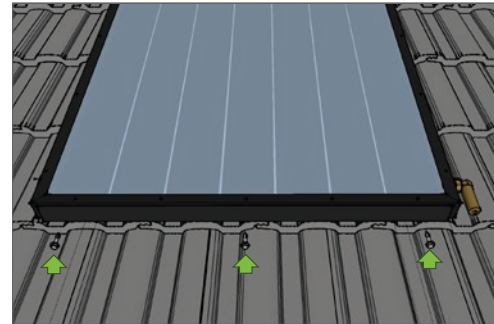

Fig 6

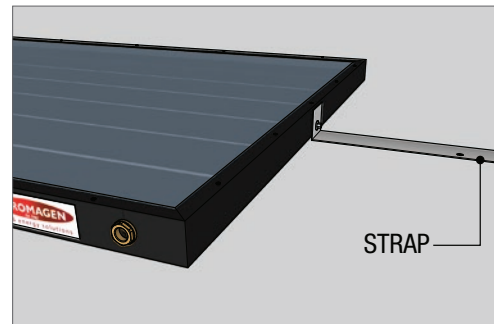

Fig 7

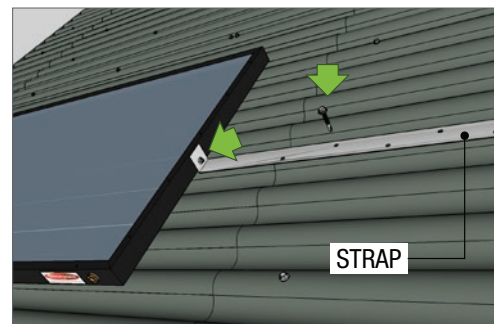

Fig 8

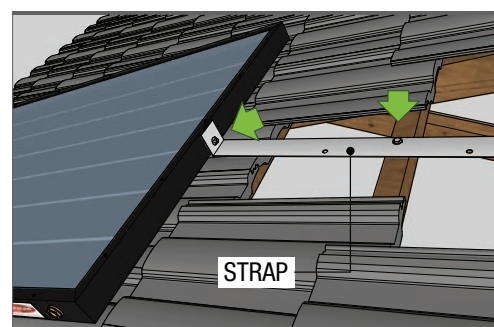

Fig 9

Installing the Horizontal Storage Tank

Preparation

1. Check the roof for broken/loose tiles and rusted/loose tin sheets, and make good?
2. Before preparing to lift the tank onto the roof area, install all brass fittings using appropriate jointing methods and referring to the tank connection table (page 3)

Fitting the tank

3. Carefully lift the storage tank into position and centralise it along the top edge of the collectors (Fig 10)
4. Fold the stainless steel straps (supplied) in half and feed them through the eyelets on the steel tank fixing lugs (Fig 11)
5. Secure the tank into position using the appropriate method below:

Tiled Roofs (Fig 12):

- a. Remove the tiles above the tank at the strap location and secure the straps to the roof battens with the screws supplied
- b. Replace tiles and make good

Tin Roofs (Fig 13):

- a. Remove screws along batten lines at the same spacing as the tank fixing lugs and run the steel straps along the peak of the corrugated sheet
 - b. Place rubber washers between steel straps and the roof surface, at the original hole location
 - c. Using the original roof-fixing screws, fix the steel straps to the roof surface
6. Complete the flow and return plumbing as per the particular system schematics (fig 14)
 7. Connect the hot & cold water pipes to the particular connections on the tank and complete the drain pipe for the PTR valve in an appropriate manner

Approved flashings must be used when penetrating the roof, following the flashing manufacturer's recommendations

Installing the gas booster (Gas models only)

1. Locate the mounting position for the gas booster (ideally in the closest proximity to the most used hot water outlet of the home)
2. Fix the booster to the wall as per the manufacturer manual (fig 15)
3. Connect up the water inlet line (from the hot outlet of the solar system)
4. Connect up the hot water line
5. Connect up the gas line

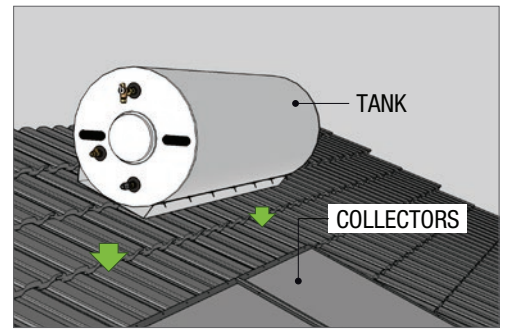

Fig 10

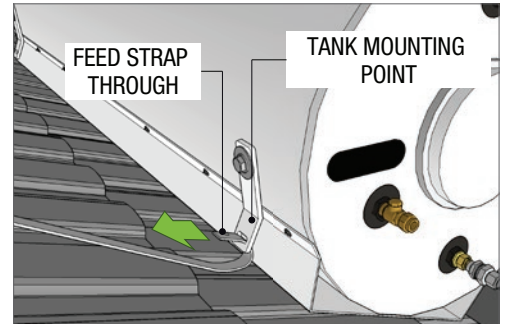

Fig 11

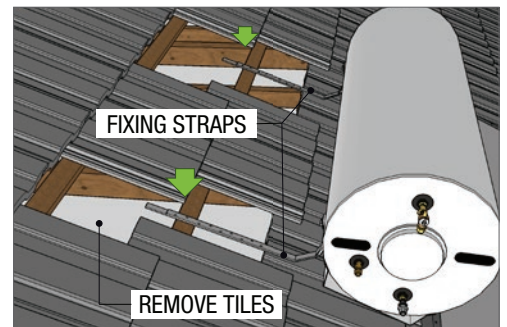

Fig 12

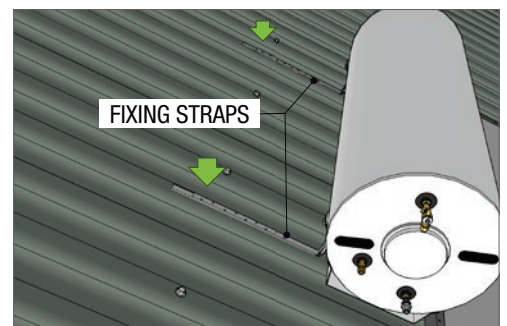

Fig 13

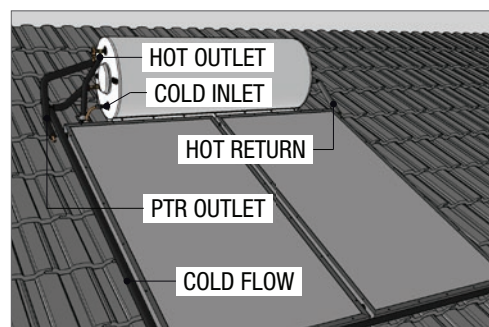

Fig 14

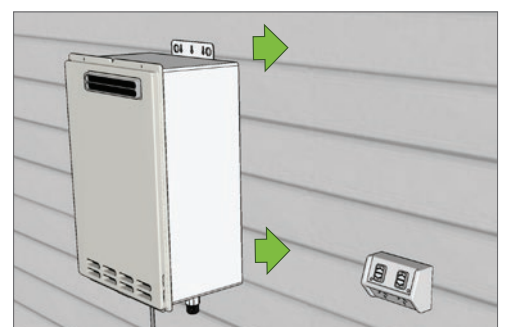



Fig 15

Filling and Commissioning an Open Loop system



WARNING

DO NOT TURN ON THE GAS BOOSTER OR ELECTRICAL ELEMENT UNTIL SYSTEM IS FULL

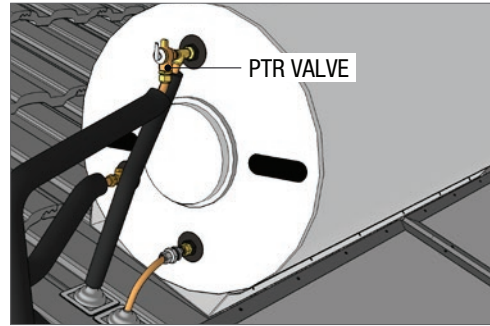

Fig 16

Filling the storage tank cylinder, solar loop & purging air

1. Ensure the system has been mounted to the roof properly and the plumbing connections are completed as per the relevant instructions
2. OPEN the mains cold water valve to the tank making sure the pressure / temperature relief (PTR) valve (Fig 16) is OPEN
3. When water flows from the PTR valve, CLOSE the PTR valve
4. Draw water through the tank by OPENING a hot water tap in the house and OPENING the cold water supply valve to the tank
5. Wait until water comes out of the hot water tap
6. Leave water running until air is bled (i.e. no more bubbles or spitting) then turn OFF the hot water tap in the house
7. Check the system for leakage by pressure testing all fittings to a minimum of 800 kPa.
8. If any leaks are detected, rectify them immediately, and then the tank is prepared for use

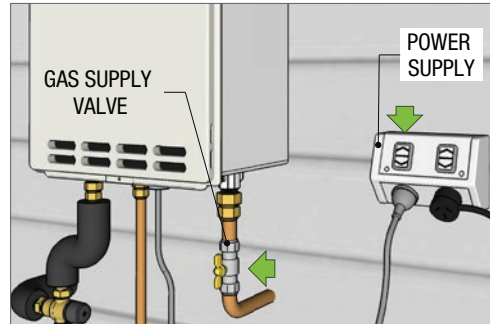

Fig 17

Activating gas booster (Gas models only)

9. Switch ON the power to the gas booster and OPEN the gas supply valve to the gas booster (Fig 17)
10. Turn ON the hot water tap inside the house to check if the booster is working
11. Test the water temperature to ensure temperature is rising
12. Set the tempering valve as per local authority / regulations

Activating the electric element (Electric models only)

13. Ensure all electrical wiring is properly configured and thermostat is calibrated (*refer to following page for instruction*)
14. Locate the switchboard and check that the hot water electric isolating switch is set to the 'ON' position. (This is usually indicated by the label 'Hot water' or 'Water heater')
15. At the tank location turn the isolating switch to the ON position.

Solar Hot Water Commissioning Check List

- Bleed all air from tank by opening hot tap inside house
- Turn on all power and gas (if applicable) and open tap inside house to check for operation
- Set the tempering valve as per local authority
- Check tank, panels and all pipe work for any leaks and repair if required
- Perform final check of overall system for operation and complete 'reference details' section of owners guide

Electrical Wiring & Cotherm Thermostat (Electric boosted systems only)



ELECTRICAL WARNING

All Electrical Connections must be made by a licensed Electrician

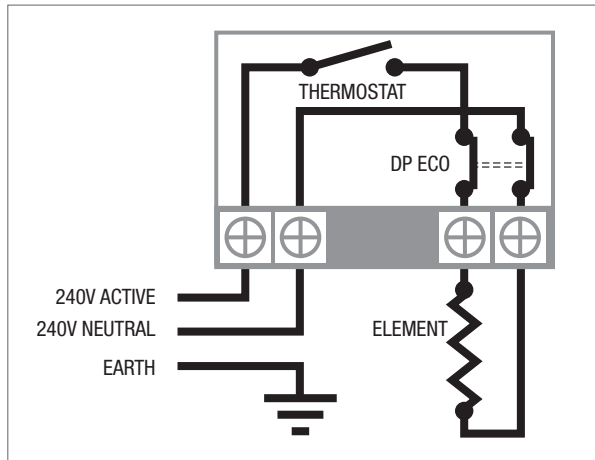

Wiring Schematic (240 VAC Single Phase)

Thermostat Wiring

- Electrically isolate thermostat from mains supply before disconnection. Failure to do so may result in an electric shock
- Wiring penetration should be made through the supplied grommet at the side of the thermostat cover. Ensure cable entry remains water tight
- All wiring must conform to AS3100 and must be performed by a licensed electrical contractor in accordance with all relevant standards
- Ensure all wiring is clear of element terminals to eliminate heat damage to wiring
- Temperature calibration should be tested at time of commissioning

Troubleshooting Tips

- No power to thermostat – check supply with multimeter, check off peak supply is operating correctly and time clock is set correctly
- No power to element – check reset button to right of dial, dial thermostat up until click is heard, measure voltage at element terminals. If no click is heard disconnect thermostat and remove from tank. Change temperature dial on thermostat, click should be heard at approximate air temperature. If not re-calibrate

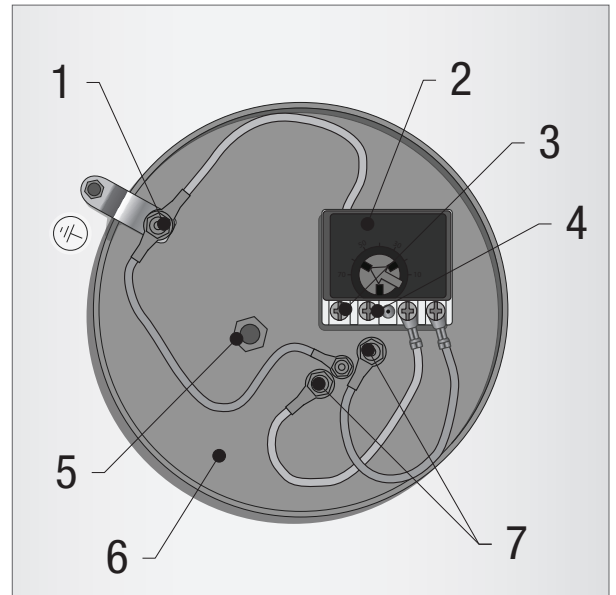

Parts: 1-Earth / 2-Thermostat / 3-Active / 4-Neutral / 5-Anode / 6-Flange / 7-Element

Tank Electrical Connections 200 / 300 Litre Tanks (Side of Tank)

Calibration Instructions

- Check temperature of probe – check as per sensor testing procedure chart using multimeter or take tank temperature from water released at PTR (ensure thermostat is situated in tank)
- Remove housing from thermostat – disconnect all power to thermostat and remove black housing cover from top of thermostat
- Calibrate thermostat – adjust thumbscrew to the middle of where thermostat clicks on and off
- Replace housing – Set temperature dial to temperature of probe and replace housing
- Check calibration – turn dial past position to ensure that thermostat clicks on and off
- Set temperature – set tank temperature to 60-65°C
- Reconnect power – Reconnect power supply to thermostat and reseal cover

Note: All thermostats should be calibrated at time of installation to avoid repeat service calls.



Looking for More
Installation Instructions?

Visit www.chromagen.com.au/shw-documentation
or scan QR code



Need the Owner's Care
& Maintenance Guide?

Visit www.chromagen.com.au/owners-guide
or scan QR code